

Commands Reference Manual

HPPS

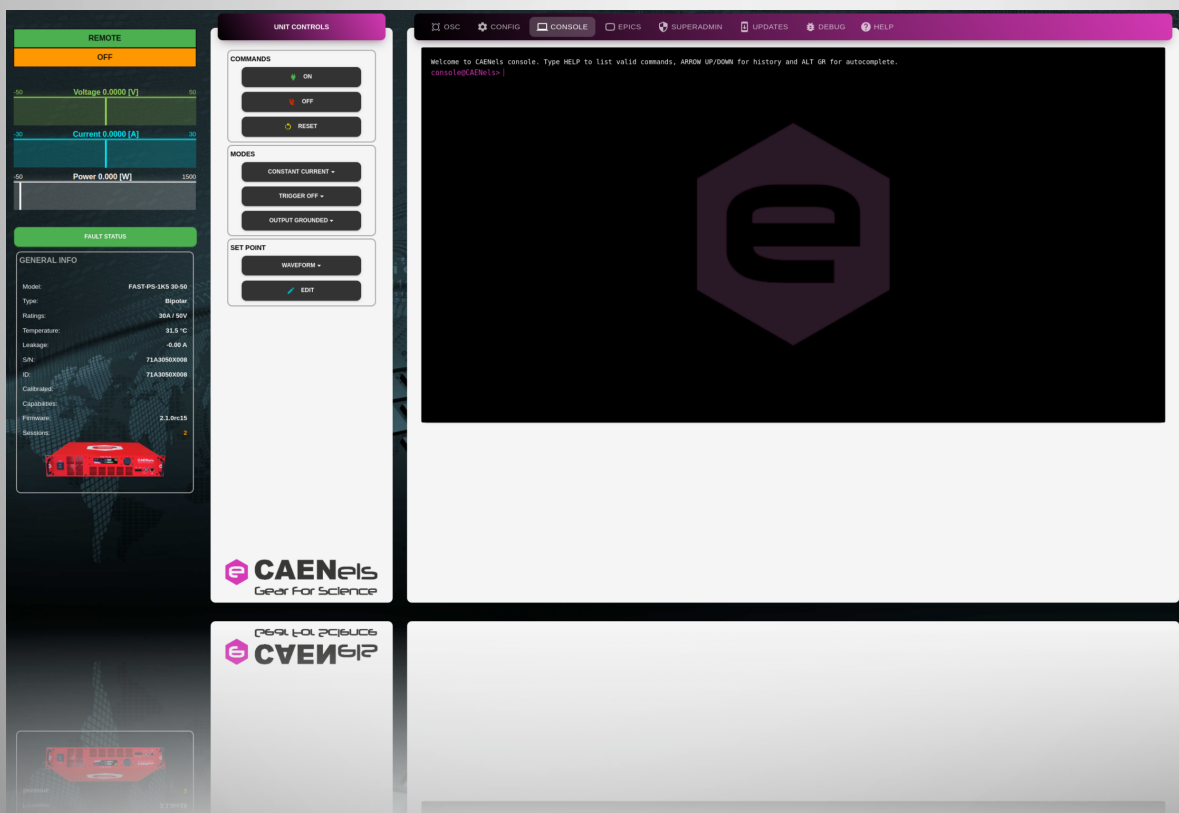

All Rights Reserved
© CAEN ELS s.r.l
Rev 1.1 - October 2024



CAEN ELS s.r.l
Via Karl Ludwig Von Bruck 32
34144 Trieste (TS)
Italy
Mail: info@caenels.com
Web: www.caenels.com

Contents

- Document Revisions** **4**

- 1 Remote interface** **5**
 - 1.1 Ethernet interface 5
 - 1.2 Command Syntax 6
 - 1.2.1 Read commands 6
 - 1.2.2 Write commands 6
 - 1.3 Command Examples 7
 - 1.4 Communication Examples 9
 - 1.4.1 Python Example 9
 - 1.4.2 Putty Example 10

- 2 Finite State Machine FSM** **11**
 - 2.1 DC FSM 12
 - 2.2 OUT FSM 14

- 3 Summary of Remote Commands** **16**
 - 3.1 Basic Commands 17
 - 3.2 Password Related Commands 18
 - 3.3 Read/Write Internal Memory Related Commands 19
 - 3.4 Status/Faults Register Related Commands 20
 - 3.5 Common Commands 21
 - 3.6 Limits Related Commands 22
 - 3.7 Mode Related Commands 23
 - 3.8 Interlocks Commands 24
 - 3.9 HPPS Specific Commands 25
 - 3.10 Advanced Features Commands 26
 - 3.11 Legacy Commands 27

- 4 Detailed Commands Description** **28**
 - 4.1 Basic Commands 29
 - 4.1.1 VER 30

4.1.2	MRID	31
4.2	Password Related Commands	32
4.2.1	PASSWORD	33
4.2.2	SETPSW	34
4.2.3	RESETPSW	35
4.3	Read/Write Internal Memory Related Commands	36
4.3.1	MRG	37
4.3.2	MWG	38
4.3.3	MSAVE	39
4.4	Faults/Status Register Related Commands	40
4.4.1	MFTR	41
4.4.2	MSTR	42
4.4.3	MRESET	43
4.5	Common Commands	44
4.5.1	OUT	45
4.5.2	MRI	46
4.5.3	MRV	47
4.5.4	MWV	48
4.5.5	MWVR	49
4.5.6	MSRV	50
4.5.7	MWI	51
4.5.8	MWIR	52
4.5.9	MSRI	53
4.5.10	MRW	54
4.5.11	MRT	55
4.5.12	UPFREQ	56
4.6	Limits Commands	57
4.6.1	MLIMITS	58
4.6.2	MPLIMITS	59
4.7	Mode Related Commands	60
4.7.1	LOOP	61
4.7.2	UPMODE	62
4.8	Interlocks Commands	63
4.8.1	INTPM	64
4.9	INTEM	66
4.9.1	INTNAME	68
4.9.2	INTIT	69

- 4.10 HPPS Specific Commands 70
 - 4.10.1 DC 71
 - 4.10.2 MRTIGBT 72
 - 4.10.3 PM 73
 - 4.10.4 MGC 75
 - 4.10.5 MRTW 76
 - 4.10.6 MRFW 77
- 4.11 Advanced Features Commands 78
 - 4.11.1 WAVE 79
 - 4.11.2 TRIG 84
- 4.12 Legacy Commands 85
 - 4.12.1 MON 86
 - 4.12.2 MOFF 87

- 5 Internal Memory 88**

- 6 Faults Register 91**

- 7 Status Register 101**

- 8 Temperatures 103**

- 9 NAK List 104**

Document Revisions

Document Revision	Date	Requirements
0.1	November 4th, 2022	First Release
1.0	April 2nd, 2024	Added new models
1.1	October 18th, 2024	Added HPPS-C2-PESY00076

1 Remote interface

It is possible to communicate with the unit using ASCII commands over the TCP/IP (or UDP) protocol on the **port 10001**.

1.1 Ethernet interface

The device is shipped with the following factory values:

Parameter	Factory value
IP	192.168.0.10
Subnet mask	255.255.255.0
Gateway	192.168.0.1
DHCP	Disabled

The Ethernet configuration can be changed using the front panel local menu.

1.2 Command Syntax

Commands are in ASCII format and are **NOT case sensitive** and therefore the command string can be sent either using uppercase or lowercase characters.

Each command is composed by one or more fields, the fields are separated by colons (":").

Each command has to be terminated with the termination sequence. Commands support two termination sequences:

- **CRLF:** "carriage return, line feed" sequence ("\r\n")
- **CR:** "carriage return" termination char ("\r")

In this documentation the commands are represented only in uppercase and the termination sequence is always represented with CRLF.

1.2.1 Read commands

The read commands are composed in the following way:

- command name (which could be followed either by one or more optional sub-commands separated by colons);
- colon (":") char;
- question mark ("?");
- termination sequence.

The reply to a read command is formed by:

- hastag ("#");
- command echo;
- colon (":") char;
- read value;
- termination sequence.

For example:

```
MRI:?\r\n
#MRI:1.0658\r\n
```

Some commands accept also read commands without the last colon (":") and question mark ("?").

1.2.2 Write commands

The write commands are composed in the following way:

- command name (which could be followed either by one or more optional sub-commands separated by colons);
- colon (":") char;
- write value;
- termination sequence.

The reply of the power supply to a write command can be:

- “#AK” (AcKnowledged): when the command has been **accepted**;
- “#NAK” (Not AcKnowledged): when the command is **NOT accepted**, followed by the corresponding error code and the error description.

For example:

```
LOOP:V\r\n
#AK\r\n

MWI:2\r\n
#NAK:13 Module is off\r\n
```

Note: By default the **NAK** (Not AcKnowledged) reply returns also the error description. The error description can be disabled acting on the “Error Code Description” field, which is editable using the *MWG* command (ID parameter “56”, see attachment *Internal Memory*). By disabling the error description, the reply is formed by the error code only, e.g.:

```
#MWI:2\r\n
#NAK:13\r\n
```

1.3 Command Examples

- Read command:

```
VER:?\r\n
#VER:NGSP 100-50:2.0.1\r\n
```

- Write command, accepted

```
LOOP:I\r\n
#AK\r\n
```

- Write command, NOT accepted

```
MWI:20\r\n
#NAK:13\r\n
```

Note 1: in the later sections the termination sequence will not be displayed for better readability, but it must be always present otherwise the commands are not parsed.

Note 2: before sending the next command, it is necessary to wait the response of the unit to the previous one.

1.4 Communication Examples

1.4.1 Python Example

By means of Python scripts it is very simple to establish a communication with the power unit. In the following example, it is possible to see how to firstly open a socket and later sent a request of the firmware version to the power unit:

```
#!/usr/bin/env python3

import socket

IP = "192.168.0.10"

try:
    # Create sockets
    s = socket.socket(socket.AF_INET, socket.SOCK_STREAM)      # TCP
    s.setsockopt(socket.SOL_SOCKET, socket.SO_REUSEADDR, 1)
    s.connect((IP, 10001))

    # Set psw
    print("Get Version")
    s.sendall("VER:?\r\n".encode())      # Note: it works also with '\r'
    terminator
    data = s.recv(2048).decode()
    print(repr(data))

    # Close socket
    s.close()

except :
    print("Error: Error in communication with the module")
```

1.4.2 Putty Example

Putty is a free telnet client that is available for both Windows and Linux OS. By means of Putty, it is possible to send commands to the power unit, by configuring the IP address of the unit, set the communication port to 10001 and finally set the connection type to “Raw”.

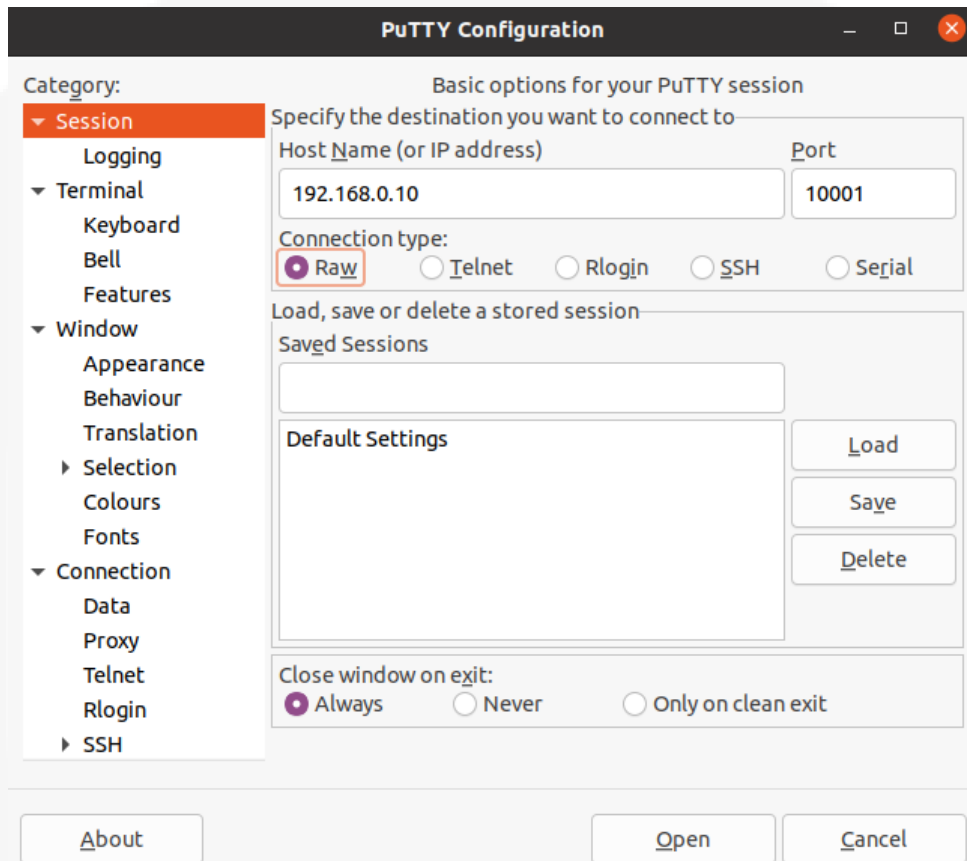

Figure 1.1: Putty Configuration

Once the configuration has been completed, it is possible to send the ASCII command directly to the unit:

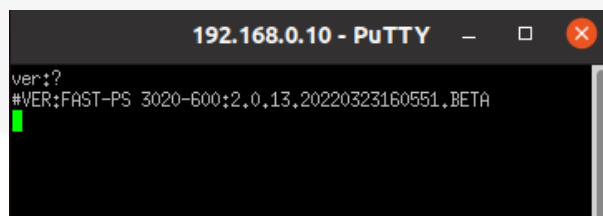

Figure 1.2: Putty Example

2 Finite State Machine FSM

The power supply is handled by a Finite State Machine (FSM).

Following event can involve a transition:

- external command
- internal transition
- fault (*Hard Fault* or *Soft Fault*)

OUT FSM control the power output.

The HPPS model uses an additional *DC FSM* to control the capacitor bank charging.

2.1 DC FSM

The *DC FSM* is the following:

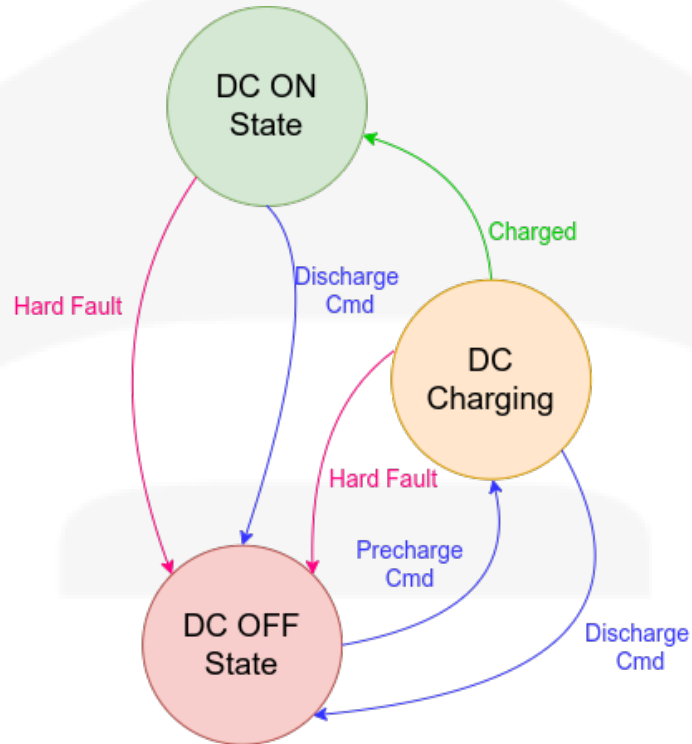

Figure 2.1: DC Link FSM

The three states are:

- **DC OFF State:** in this state the capacitor bank is discharged. This is the default state at machine startup.
- **DC Charging State:** in this state the precharge contactor is closed and the capacitor bank is in charging state. Once the capacitor banks reaches the nominal voltage value, the machine evolves to **DC ON State**.
- **DC ON State:** the capacitor bank is charged and the machine is ready to operate.

The transition between the states are the following:

- **Command-related transitions** (in blue): that are defined by software commands (e.g. **DC:ON** DC-link charge command or **DC:OFF** DC-link discharge command).
- **Fault-related transitions** (in red): that are driven by a **Fault condition**. When a fault occurs, the machine is in a **Fault State**.

There are two types of *Fault condition*: *Soft Fault* and *Hard Fault*. *Soft Fault* is not critical for DC-link charging and so the *DC FSM* ignore it. Otherwise with a *Hard Fault*, the *DC FSM* evolves to **DC OFF State**.

- **Internal transitions** (in green): there is only one internal transition that is related to the charging state of the DC-link. This transition occurs when the capacitor bank voltage reaches the nominal value and the *DC FSM* automatically switches to the **DC ON State**.

2.2 OUT FSM

Once the capacitor bank is charged (*DC FSM* is in **DC ON State**), it is possible to let the *OUT FSM* evolve. When the capacitor bank is not ready (the *DC FSM* is either in **DC Charging State** or **DC OFF State**), the *OUT FSM* remains in **OUT OFF State**.

The *OUT FSM* is the following:

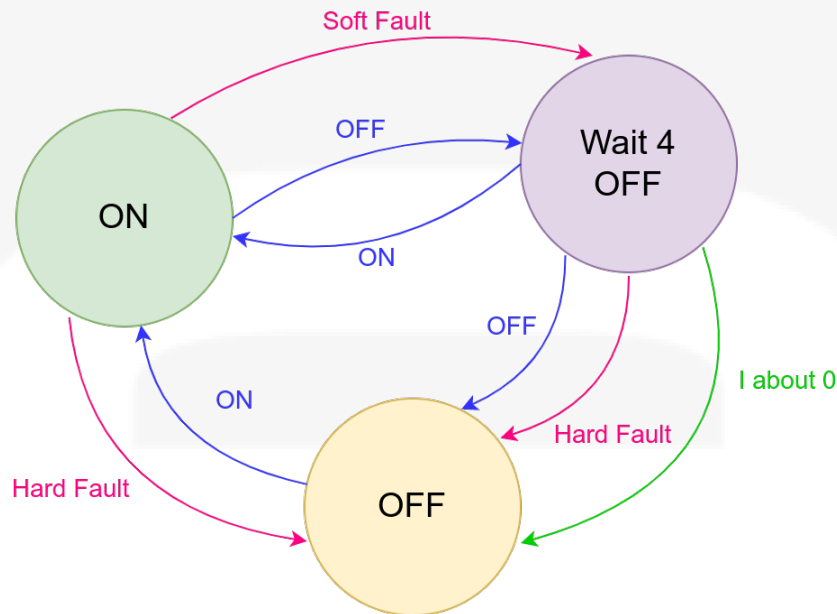

Figure 2.2: Output FSM

The three states are:

- **OUT OFF State:** in this state the output drivers and PID regulator are disabled. This is the default state at machine startup.
- **OUT Wait for Off State:** in this state the unit performs a ramp-down to 0V and waits until the output current reaches 0A. When the current is about 0A, the unit evolves to **OUT OFF State**.
- **OUT ON State:** in this state the output drivers and PID regulator are enabled and the unit can accept a new setpoint. The default setpoint that is set, when the output is enabled is 0A in *CC Mode* or 0V in *CV Mode* (see *Mode Related Commands* chapter).

The transition between the states are the following:

- **Command-related transitions** (in blue): that are defined by software commands (for example by **OUT:ON** or **OUT:OFF** commands)

- **Fault-related transitions** (in red): that are defined by a **Fault condition**. When a fault occurs, the machine is in a **Fault State**.

There are two types of *Fault condition*: *Soft Fault* and *Hard Fault*. *Soft Fault* is the one that does not impact on the machine regulation and so the *OUT FSM* goes to **OUT Wait for Off State** in which the output is set to 0V and when the current is about 0A, the module goes to **OUT OFF State**. Otherwise with a *Hard Fault*, the machine is not able to regulate the output and so the FSM evolves directly to **OUT OFF State**.

- **Internal transitions** (in green): there is only one internal transition that is related to the output current. This transition is used only when the *OUT FSM* is in **OUT Wait for Off State** and the output current is close to 0A, at this point the *OUT FSM* can evolve to **OUT OFF State**.

3 Summary of Remote Commands

The list of the commands used by power units and the corresponding syntax is listed in the following sections.

3.1 Basic Commands

Command	R/W	Options	Short Description
VER	R	VER:?	Gets module model and the installed firmware version
MRID	R	MRID:?	Gets module identification

3.2 Password Related Commands

Command	R/W	Options	Short Description
PASSWORD	R	PASSWORD:?	Queries the actual user privileges
	W	PASSWORD:*****	Sets the password
	W	PASSWORD:LOCK	Restores <i>USER</i> privileges
SETPSW	W	SETPSW:<password>	Changes default <i>ADMIN</i> password
RESETPSW	W	RESETPSW:<reset_pin>	Resets <i>ADMIN</i> password

3.3 Read/Write Internal Memory Related Commands

Command	R/W	Options	Short Description
MRG	R	MRG:<id>:?	Reads the given parameter field
MWG	W	MWG:<id>:<value>	Writes to the given parameter field
MSAVE	W	MSAVE	Saves the parameter in the non-volatile memory

3.4 Status/Faults Register Related Commands

Command	R/W	Options	Short Description
MFTR	R	MFTR:?	Gets module <i>Faults Register</i>
MSTR	R	MSTR:?	Gets module <i>Status Register</i>
MRESET	W	MRESET	Reset <i>Faults Register</i>

3.5 Common Commands

Command	R/W	Options	Short Description
OUT	R	OUT?	Queries <i>OUT</i> State
	W	OUT:ON	Enables module output
	W	OUT:OFF	Disable module output
MRI	R	MRI:?	Reads output current
MRV	R	MRV:?	Reads output voltage
MWV	R	MWV:?	Queries last voltage setpoint
	W	MWV:<float>	Sets output voltage setpoint
MWVR	R	MWVR:?	Queries last voltage setpoint
	W	MWVR:<float>	Goes at voltage setpoint through a ramp
MSRV	R	MSRV:?,	Queries voltage ramp slew rate
	W	MSRV:<float>	Sets voltage ramp slew rate
	R	MSRV:MAX:?	Gets maximum voltage ramp slew rate
MWI	R	MWI:?	Queries last current setpoint
	W	MWI:<float>	Sets output current setpoint
MWIR	R	MWIR:?	Queries last current setpoint
	W	MWIR:<float>	Goes at current setpoint through a ramp
MSRI	R	MSRI:?	Queries current ramp slew rate
	W	MSRI:<float>	Sets current ramp slew rate
	R	MSRI:MAX:?	Gets maximum current ramp slew rate
MRW	R	MRW:?	Gets the active output power
MRT	R	MRT:?	Reads temperatures
	R	MRT:NUM:?	Gets number of temperatures
	R	MRT:ALL:?	Gets all temperatures
	R	MRT:<id>:?	Reads given temperature
UPFREQ	R	UPFREQ:?	Gets <i>Update Frequency</i>

3.6 Limits Related Commands

Command	R/W	Options	Short Description
MLIMITS	R	MLIMITS:?	Gets hardware V and I limits
	R	MLIMITS:HW:?	Gets hardware V and I limits
	R	MLIMITS:SW:?	Gets software V and I limits
MPLIMITS	R	MPLIMITS:?	Gets power limits

3.7 Mode Related Commands

Command	R/W	Options	Short Description
LOOP	R	LOOP:?	Queries <i>Loop Mode</i>
	W	LOOP:<mode>	Sets <i>Loop Mode</i>
UPMODE	R	UPMODE:?	Queries module <i>Update Mode</i>
	W	UPMODE:<mode>	Sets the module <i>Update Mode</i>
	R	UPMODE:LIST:?	Gets <i>Update Mode</i> list

3.8 Interlocks Commands

Command	R/W	Options	Short Description
INTPM	R	INTPM:?	Queries <i>Interlock Polarity Mask</i>
	W	INTPM:<mask>	Sets <i>Interlock Polarity Mask</i>
	R	INTPM:<id>:?	Queries <i>Interlock Polarity</i>
	W	INTPM:<id>:<polarity>	Sets <i>Interlock Polarity</i>
INTEM	R	INTEM:?	Queries <i>Interlock Event Mask</i>
	W	INTEM:<mask>	Sets <i>Interlock Event Mask</i>
	R	INTEM:<id>:?	Queries <i>Interlock Event</i>
	W	INTEM:<id>:<status>	Sets <i>Interlock Event</i>
INTNAME	R	INTNAME:<id>:?	Queries <i>Interlock Name</i>
	W	INTNAME:<id>:<name>	Sets <i>Interlock Name</i>
INTIT	R	INTIT:<id>:?	Queries <i>Interlock Intervention Time</i>
	W	INTIT:<id>:<time>	Sets <i>Interlock Intervention Time</i>

3.9 HPPS Specific Commands

Command	R/W	Options	Short Description
DC	R	DC:?	Queries <i>DC State</i>
	W	DC:ON	Enables module DC
	W	DC:OFF	Disable module DC
MRTIGBT	R	MRTIGBT:?	Reads maximum IGBT temperature
	R	MRTIGBT:ALL:?	Reads IGBT temperatures of all modules
	R	MRTIGBT:<id>:?	Reads IGBT temperatures
PM	R	PM:?	Queries <i>Power Module Status</i> of all modules
	R	PM:<id>:?	Queries <i>Power Module Status</i>
	R	PM:NUM:?	Gets number of <i>Power Module</i>
MGC	R	MGC:?	Reads leakage ground current ¹
MRTW	R	MRTW:?	Reads water temperature ¹
MRFW	R	MRFW:?	Reads water flow ¹

1: HPPS-C2-PESY00076 model only

3.10 Advanced Features Commands

Command	R/W	Options	Short Description
WAVE	W	WAVE:START	Starts waveform generation
	W	WAVE:STOP	Stops waveform generation
	R	WAVE:N_PERIODS:?	Queries waveform number of periods
	W	WAVE:N_PERIODS:<value>	Sets waveform number of periods
	R	WAVE:PRESCALER:?	Queries waveform prescaler value
	W	WAVE:PRESCALER:<value>	Sets waveform prescaler value
	R	WAVE:POINTS:?	Queries waveform points
	W	WAVE:POINTS:<p_1>:<p_2>:...:<p_x>	Sets waveform points
	R	WAVE:TRIGGER:?	Queries <i>Wave Trigger Mode</i>
	W	WAVE:TRIGGER:START	Sets <i>Wave Trigger Mode</i> to <i>START</i>
	W	WAVE:TRIGGER:POINTS	Sets <i>Wave Trigger Mode</i> to <i>POINTS</i>
	W	WAVE:TRIGGER:GATE	Sets <i>Wave Trigger Mode</i> to <i>GATE</i>
	W	WAVE:TRIGGER:GATE_RESET	Sets <i>Wave Trigger Mode</i> to <i>GATE_RESET</i>
	TRIG	R	TRIG:?
W		TRIG:<mode>	Sets <i>Trigger Mode</i>

3.11 Legacy Commands

Command	R/W	Options	Short Description
MON	W	MON	Turn ON the module
MOFF	W	MOFF	Turn OFF the module

4 Detailed Commands Description

This section includes the detailed description of the power supply commands.

4.1 Basic Commands

Commands used to identify the devices.



4.1.1 VER

The **VER** command returns the power supply model and the actual installed firmware version.

R/W	Command	Response
R	VER:?	#VER:<name>:<version>

Parameters:

Name	Description
<i>name</i>	Device name
<i>version</i>	Firmware version

Examples:

```
VER: ?
#VER:NGPS 100-50:2.1.01
```

4.1.2 MRID

The **MRID** command returns the identification name string of the module (see attachment *Internal Memory*) to easily identify the power supply among the other ones connected in the same network. The default ID is the serial number.

The ID can be set using the command *MWG:30* (see *MWG* command)

R/W	Command	Response
R	MRID:?	#MRID:<name>

Parameters:

Name	Description
<i>name</i>	Device identification name

```
MRID: ?
#MRID:PS_01
```

4.2 Password Related Commands

Commands used to log in the power supply and handle the passwords.

The power supply has two levels of privileges:

- **USER**
- **ADMIN**

With *USER* privileges it is possible to write only basic parameters (such as slew-rate etc.), otherwise with *ADMIN* privileges, it is possible to configure the power supply parameters (such as the PID parameters, interlocks etc.).

For the whole list of parameters and of privileges needed to modify them see attachment *Internal Memory*.

4.2.1 PASSWORD

The **PASSWORD** command is used to change the user privileges.

R/W	Command	Response
R	PASSWORD:?	#PASSWORD:<privileges>
W	PASSWORD:<password>	#AK

Parameters:

<i>privileges</i>	Description
USER	Lowest privileges level: it can modify only very basic parameters and use only some commands
ADMIN	Highest privileges level: it can modify all available parameters and use all commands

<i>password</i>	Description
LOCK	<i>USER</i> associated password
USER	Equivalent to <i>LOCK</i> (no longer supported)
PS-ADMIN	<i>ADMIN</i> associated password (see <i>SETPSW</i> command to change it)

Examples:

```
PASSWORD: LOCK
#AK

PASSWORD: ?
#PASSWORD: ADMIN
```

4.2.2 SETPSW

The **SETPSW** command is used to change the *ADMIN* password (default is “*PS-ADMIN*”). To change the password it is necessary to have already the *ADMIN* privileges.

R/W	Command	Response
W	SETPSW:<password>	#AK

Parameters:

Name	Type	Description
<i>password</i>	string ¹	New password associated to ADMIN

1: string cannot contain special character (e.g. "?") or be empty

IMPORTANT:

Pay attention: if the custom password is lost it will not be possible to access with *ADMIN* privileges to the power unit.

To restore the default password see *RESETPSW* command.

Examples:

```
SETPSW:<password>
```

4.2.3 RESETPSW

The **RESETPSW** command is used to restore the default *ADMIN* password word (default is *PS-ADMIN*). To restore the password it is necessary to insert the *reset_pin*; to get it is necessary to contact the CAENels support.

R/W	Command	Response
W	RESETPSW:<reset_pin>	#AK

Parameters:

Name	Type	Description
<i>reset_pin</i>	hex ¹	Code provided by CAENels

1: It is a code that doesn't start with '0x'

Examples:

```
RESETPSW:0123456789ABCDEF0123456789ABCDEF
```

4.3 Read/Write Internal Memory Related Commands

Commands used to read and write *Internal Memory* parameters.

See attachment *Internal Memory* for:

- whole list of parameters
- type of parameter
- privileges needed to modify a field
- description

The *Internal Memory* is model/family dependent.

4.3.1 MRG

The **MRG** command returns the value of the given parameter identifier.
See attachment *Internal Memory*.

R/W	Command	Response
R	MRG:<id>:?	MRG:<id>:<value>

Parameters:

Name	Type	Range	Description
<i>id</i>	int	see attachment <i>Internal Memory</i>	<i>Internal Memory</i> field ID
<i>value</i>	see attachment <i>Internal Memory</i>	-	Value of <i>Internal Memory</i> field

Examples:

```
MRG:0:?
#MRG:0:FAST-PS
```

4.3.2 MWG

The **MWG** command is used to write a desired value in the given parameter identifier.
See attachment *Internal Memory*.

R/W	Command	Response
W	MWG:<id>:<value>	#AK

Parameters:

Name	Type	Range	Description
<i>id</i>	int	see attachment <i>Internal Memory</i>	<i>Internal Memory</i> field ID
<i>value</i>	see attachment <i>Internal Memory</i>	-	Value of <i>Internal Memory</i> field

Examples:

```
MWG:30:DEVICE_01
#AK
```

4.3.3 MSAVE

The **MSAVE** command is used to store parameter fields in the non-volatile memory, otherwise they will be lost at the unit power-off.

R/W	Command	Response
W	MSAVE	#AK

MSAVE
#AK

4.4 Faults/Status Register Related Commands

The *Fault condition* are latched and stored in the *Faults Register*.

When the module reaches a *Fault condition*, the relative bit in the *Faults Register* is set.

If the module *Faults Register* is not zero, the module is in **Fault State**.

Faults are classified as *Hard Fault* or *Soft Fault*.

In *Fault State* the *OUT FSM* evolves to **OUT OFF State**, where output is disabled. The *OUT FSM* evolution depends on fault type (see *Finite State Machine FSM* chapter).

In *Fault State* the *DC FSM* evolves concordly with the fault type.

In case of *Hard Fault* (for example a Emergency Button pushed), *DC FSM* evolves to *DC OFF State* where the DC-Link is disabled (capacitor bank is discharged). *DC FSM* ignores *Soft Fault*.

To restore the *Faults Register* to 0, it is necessary to reset itself using the *MRESET* command.

See attachment *Faults Register* for:

- fault associated bit
- fault name
- fault description

Faults Register is family/model dependent.

The *Status Register* provides some informations about the power supply status.

See attachment *Status Register* for:

- status associated bit
- status value
- status description

Status Register is family dependent.

4.4.1 MFTR

The **MFTR** command returns the *Faults Register*.

See attachment *Faults Register*.

R/W	Command	Response
R	MFTR:?	MFTR:<faults>

Parameters:

Name	Type	Size	Description
<i>faults</i>	hex	64bits	<i>Faults Register</i> (LSB is associated to fault 1)

Examples:

```
MFTR:?
MFTR:0x0
```

4.4.2 MSTR

The **MSTR** command returns internal *Status Register*.

See attachment *Status Register*.

R/W	Command	Response
R	MSTR:?	MSTR:<status>

Parameters:

Name	Type	Size	Description
<i>status</i>	hex	64bits	<i>Status Register</i> (LSB is associated to status 1)

Examples:

```
MSTR:?
MSTR:0x1
```

4.4.3 MRESET

The MRESET performs a reset of the module *Faults Register*.
System exits from **Fault State**.

R/W	Command	Response
W	MRESET	#AK

Examples:

```
MRESET
#AK
```

4.5 Common Commands

The commands used to turn on and turn off the power supply, set setpoint, read current and voltage output and some common readback (as temperatures).

4.5.1 OUT

The **OUT** command is used to evolve the *OUT FSM* and query the actual state.

R/W	Command	Response
R	OUT:?	#OUT:<status>
W	OUT:<status>	#AK

Parameters:

status	Mode	Description
ON	R	<i>Power Module</i> is enabled, it is ready to regulate ¹ and to have connected a load
	W	<i>OUT FSM</i> evolves from <i>OUT OFF State</i> (or <i>OUT Wait for Off State</i>) to <i>OUT ON State</i>
OFF ¹	R	The output driver is disabled
	W	<i>OUT FSM</i> evolves from <i>OUT ON State</i> state to <i>OUT Wait for Off State</i> ²
WAIT4OFF	R	The power supply is performing a ramp down to zero (the slew-rate of the ramp is factory defined)

1: In **CV Mode** voltage output is set to 0V, in **CC Mode** current output is set to 0A (see **LOOP** command)

2: If **OUT FSM** is in **OUT Wait for Off State**, **OUT:OFF** command forces **OUT FSM** to **OUT OFF State**

Examples:

```
OUT: ?
#OUT: OFF
```

```
OUT: ON
#AK
```

4.5.2 MRI

The **MRI** command returns the readback value of the power supply output current.

R/W	Command	Response
R	MRI:?	#MRI:<value>

Parameters:

Name	Type	Unit	Description
<i>value</i>	float	A	Output current

Examples:

```
MRI:?  
#MRI:10.1234567
```

4.5.3 MRV

The **MRV** command returns the readback value of the power supply output voltage.

R/W	Command	Response
R	MRV:?	#MRV:<value>

Parameters:

Name	Type	Unit	Description
<i>value</i>	float	V	Output voltage

Examples:

```
MRV:?  
#MRV:10.1234567
```

4.5.4 MWV

The **MWV** command is used to set the output voltage during the *CV Mode* (see *LOOP* command), or query the last voltage setpoint.

A *Trigger Event* indicates when the setpoint become effective (see *TRIG* command).

R/W	Command	Response
R	MWV:?	#MWV:<value>
W	MWV:<value>	#AK

Parameters:

Name	Type	Unit	Description
<i>value</i>	float	V	Desired output voltage value

The output voltage can be set only during *OUT ON State* and if *NORMAL Update Mode* is selected (see *UPMODE* command) and *CV Mode* is used (see *LOOP* command).

Examples:

```
MWV : ?
MWV : 5.0000000

MWV : 35
#AK
```

4.5.5 MWVR

The **MWVR** command is used to achieve the set output voltage through a ramp, whose slew rate could be changed (see *MSRV* command), or query the last voltage setpoint.

A *Trigger Event* indicates when the setpoint become effective (see *TRIG* command).

R/W	Command	Response
R	MWVR:? ¹	#MWVR:<value>
W	MWVR:<value>	#AK

¹: equivalent to *MWV* command

Parameters:

Name	Type	Unit	Description
<i>value</i>	float	V	Desired output voltage value

The output voltage can be set only during *OUT ON State* and if *NORMAL Update Mode* is selected (see *UPMODE* command) and *CV Mode* is used (see *LOOP* command).

Examples:

```
MWIR:?
#MWI:15.0000000

MWVR:10
#AK
```

4.5.6 MSRV

The **MSRV** command is used to dynamically set or queries the voltage ramp slew rate. It is possible also get the maximum voltage slew rate.

R/W	Command	Response
R	MSRV:?	#MSRV:<value>
W	MSRV:<value>	#AK
R	MSRV:MAX:?	#MSRV:MAX:<max_value>

Parameters:

Name	Type	Range	Unit	Description
<i>value</i>	float	(0, <i>max_value</i>]	V/s	Voltage slew rate
<i>max_value</i>	float	-	V/s	Maximum voltage slew rate

Examples:

```
MSRV:?  
#MSRV:30.0000000  
  
MSRV:15  
#AK  
  
MSRV:MAX:?  
#MSRV:MAX:50.0000000
```

4.5.7 MWI

The **MWI** command is used to set the output current during the *CC Mode* (see *LOOP* command), or query the last current setpoint.

A *Trigger Event* indicates when the setpoint become effective (see *TRIG* command).

R/W	Command	Response
R	MWI:?	#MWI:<value>
W	MWI:<value>	#AK

Parameters:

Name	Type	Unit	Description
<i>value</i>	float	A	Desired output current value

The output current can be set only during *OUT ON State* and if *NORMAL Update Mode* is selected (see *UPMODE* command) and *CC Mode* is used (see *LOOP* command).

Examples:

```
MWI : ?
MWI : 10.0000000

MWI : 15
#AK
```

4.5.8 MWIR

The **MWIR** command is used to achieve the set output current through a ramp, whose slew rate could be changed (see *MSRI* command), or query the last current setpoint.

A *Trigger Event* indicates when the setpoint become effective (see *TRIG* command).

R/W	Command	Response
R	MWIR:? ¹	#MWIR:<value>
W	MWIR:<value>	#AK

1: equivalent to *MWI* command

Parameters:

Name	Type	Unit	Description
value	float	A	Desired output current value

The output current can be set only during *OUT ON State* and if *NORMAL Update Mode* is selected (see *UPMODE* command) and *CC Mode* is used (see *LOOP* command).

Examples:

```
MWIR:<setpoint>
#AK

MWIR:?
#MWI:<setpoint>
```

4.5.9 MSRI

The **MSRI** command is used to dynamically set or get the current ramp slew rate. It is possible also query the maximum current slew rate.

R/W	Command	Response
R	MSRI:?	#MSRI:<value>
W	MSRI:<value>	#AK
R	MSRI:MAX:?	#MSRI:MAX:<max_value>

Parameters:

Name	Type	Range	Unit	Description
<i>value</i>	float	(0, <i>max_value</i>]	A/s	Current slew rate
<i>max_value</i>	float	-	A/s	Maximum current slew rate

Examples:

```
MSRI:10
#AK

MSRI:?
#MSRI:15

MSRI:MAX:?
#MSRI:MAX:30
```

4.5.10 MRW

The **MRW** command returns the value of the active output power, estimated as the product between the output voltage and output current readbacks.

R/W	Command	Response
R	MRW:?	#MRW:<value>

Parameters:

Name	Type	Unit	Description
<i>value</i>	float	W	Active power

Examples:

```
MRW: ?
#MRW: 23.5489764
```

4.5.11 MRT

The **MRT** query the power supply temperatures.
 It is possible also get the number of available temperatures.
 See attachment *Temperatures* for more informations.

R/W	Command	Response
R	MRT:?	#MRT:<max_temp>
R	MRT:NUM:?	#MRT:NUM:<temp_number>
R	MRT:ALL:?	#MRT:ALL:<temp_1>:<temp_x>:...
R	MRT:<x>:?	#MRT:<x>:<temp_x>

Parameters:

Name	Type	Range	Description
<i>temp_number</i>	int	[1,3] ¹	Number of available temperatures
<i>x</i>	int	[1,3] ¹	Temperature number

1: Available temperatures are family/model dependent

max_temp / temp_x	Type	Unit
(Max) Temperature	float	°C

Examples:

```
MRT:?  
#MTR:33.5  
  
MRT:NUM:?  
#MRT:NUM:3  
  
MRT:ALL:?  
#MRT:ALL:35.6:38.4:65.1  
  
MRT:1:?  
#MRT:1:32.6
```

4.5.12 UPFREQ

The **UPFREQ** command gets the power supply *Update Frequency*.

Update frequency is model/family dependent.

R/W	Command	Response
R	UPFREQ:?	#UPFREQ:<frequency>

Parameters:

Name	Unit	Description
<i>frequency</i>	Hz	<i>Update Frequency</i> used by PID and waveform generator (see <i>WAVE</i> command)

Examples:

```
UPFREQ:?  
#UPFREQ:100000
```

4.6 Limits Commands

The power supply has two type of internal limits for current and voltage:

- Hardware limits *HW Limits*
- Software limits *SW Limits*

HW Limits are factory defined and rapresents power supply limits.

SW Limits are user defined. These limits prevent setting the setpoint out of safe range.
See attachment *Internal Memory* to change these values.

From *HW Limits* derives *Power Limits*

4.6.1 MLIMITS

The **MLIMITS** command queries the current and voltage limits.

R/W	Command	Response
R	MLIMITS:?	#MLIMITS:<hw_min_V>:<hw_max_V>:<hw_min_I>:<hw_max_I>
R	MLIMITS:HW:?	#MLIMITS:<hw_min_V>:<hw_max_V>:<hw_min_I>:<hw_max_I>
R	MLIMITS:SW:?	#MLIMITS:<sw_min_V>:<sw_max_V>:<sw_min_I>:<sw_max_I>

Parameters:

Name	Type	Unit	Description
<i>hw_min_V</i>	float	V	Hardware minimum voltage
<i>hw_max_V</i>	float	V	Hardware maximum voltage
<i>hw_min_I</i>	float	A	Hardware minimum current
<i>hw_max_I</i>	float	A	Hardware maximum current
<i>sw_min_V</i>	float	V	Software minimum voltage
<i>sw_max_V</i>	float	V	Software maximum voltage
<i>sw_min_I</i>	float	I	Software minimum current
<i>sw_max_I</i>	float	I	Software maximum current

Examples:

```
MLIMITS:?
#MLIMITS:-10:10:-30:30

MLIMITS:HW:?
#MLIMITS:-10:10:-30:30

MLIMITS:SW:?
#MLIMITS:0:10:0:20
```

4.6.2 MPLIMITS

The **MPLIMITS** command returns the value of maximum allowed output active power.

R/W	Command	Response
R	MPLIMITS:?	#MPLIMITS:<min_power>:<max_power>

Parameters:

Name	Type	Unit	Description
<i>min_power</i>	float	W	Minimum allowed active power
<i>max_power</i>	float	W	Maximum allowed active power

Examples:

```
MPLIMITS:?  
#MPLIMITS:0:200
```

4.7 Mode Related Commands

Commands used to handle *Loop Mode* and *Update Mode*.

The *Loop Mode* selects the loop control:

- *Constant-Current CC Mode*
- *Constant-Voltage CV Mode*

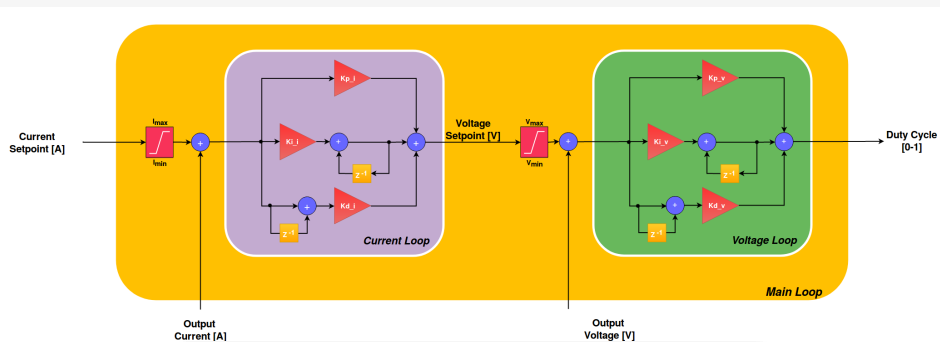

Figure 4.1: CC Mode

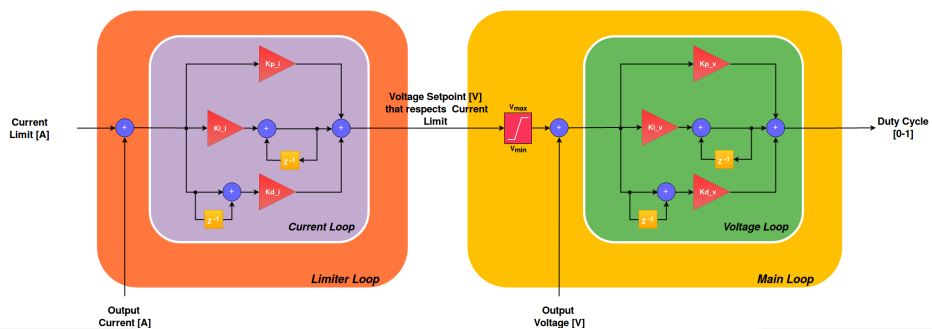

Figure 4.2: CV Mode

The *Update Mode* selects how setpoint is updated.

4.7.1 LOOP

The **LOOP** command is used to select or get the regulation mode of the power supply.

R/W	Command	Response
R	LOOP:?	#LOOP:<mode>
W	LOOP:<mode>	#AK

Parameters:

<i>mode</i>	Description
I	CC Mode
V	CV Mode

Loop Mode cannot be set whe the module is in *OUT ON State*.

Examples:

```
LOOP:?
#LOOP:I

LOOP:V
#AK
```

4.7.2 UPMODE

The **UPMODE** command allows the user to select or read the *Update Mode*. It can be used also to list the available options.

R/W	Command	Response
R	UPMODE:?	#UPMODE:<mode>
W	UPMODE:<mode>	#AK
R	UPMODE:LIST:?	#UPMODE:<mode_0>:<mode_1>:...: <mode_x>

Parameters:

<i>mode / mode_x</i>	Description
NORMAL	Setpoint is set using standard Ethernet communication
WAVE	Internal function generator
ANALOG ¹	Setpoint is set using analog input [-10V,+10V]
SFP ²	Exploit the optical SFP transceiver and support parallel connection

1: Family and model dependent

2: Family dependent

Examples:

```
UPMODE:WAVE
#AK

UPMODE:?
#UPMODE:NORMAL

UPMODE:LIST:?
#UPMODE:LIST:NORMAL:WAVE:AIN:SFP
```

4.8 Interlocks Commands

Commands used to set more external interlocks.

An external interlocks event generates a *Soft Fault* (see *Faults/Status Register Related Commands* and *Finite State Machine FSM* chapters).

With following commands it is possible:

- enable/disable interlocks
- set interlocks polarity
- change the default interlocks name
- set an intervention time

4.8.1 INTPM

The **INTPM** command reads or sets the interlocks polarity.

It is possible set the polarity for a single or all interlocks simultaneously.

R/W	Command	Response
R	INTPM:?	#INTPM:<mask>
W	INTPM:<mask>	#AK
R	INTPM:<id>:?	#INTPM:<id>:<polarity>
W	INTPM:<id>:<polarity>	#AK

Parameters:

Name	Type	Range	Description
mask	hex	[0x0,0xF] ¹	Interlocks polarity mask (LSB is associated to interlock 0)
id	int	[0,4] ¹	Interlock ID
polarity	bit	[0x0;0x1]	Interlock polarity

1: Family dependent

polarity	Description
0x0	Direct polarity
0x1	Inverted polarity

Examples:

```
INTPM: ?
#INTPM: 0x3

INTPM: 0x2
#AK

INTPM: 1: ?
#INTPM: 1: 0x1
```

`INTPM:0:0x0`
`#AK`

4.9 INTEM

The **INTEM** command enables or disables the interlocks.

It is possible enable or disable a single or all interlocks simultaneously.

R/W	Command	Response
R	INTEM:?	#INTEM:<mask>
W	INTPM:<mask>	#AK
R	INTPM:<id>:?	#INTEM:<id>:<status>
W	INTPM:<id>:<status>	#AK

Parameters:

Name	Type	Range	Description
mask	hex	[0x0,0xF] ¹	Interlocks enable mask (LSB is associated to interlock 0)
id	int	[0,4] ¹	Interlock ID
status	bit	[0x0;0x1]	Interlock status

1: Family dependent

status	Description
0x0	Disabled
0x1	Enabled

Examples:

```
INTPM: ?
#INTPM: 0x1

INTPM: 0x3
#AK

INTPM: 0: ?
#INTPM: 0: 0x0
```

`INTPM:1:0x1`
`#AK`

4.9.1 INTNAME

The **INTNAME** command gets or sets the interlocks name.

R/W	Command	Response
R	INTNAME:<id>:?	#INTNAME:<id>:<name*>
W	INTNAME:<id>:<name>	#AK

Parameters:

Name	Type	Range	Description
id	int	[0,4] ¹	Interlock ID
name	string ²	-	Interlock name

1: Family dependent

2: string cannot contain special character (e.g. "?") or be empty.

Examples:

```
INTNAME:0:?
#INTNAME:0:Interlock 0

INTNAME:1:Int1
#AK
```

4.9.2 INTIT

The **INTIT** command gets or sets the interlocks intervention time.

R/W	Command	Response
R	INTIT:<id>:?	#INTIT:<id>:<time>
W	INTIT:<id>:<time>	#AK

Parameters:

Name	Type	Range	Unit	Description
id	int	[0:4] ¹	-	Interlock ID
time	int	[0:10000]	ms	Interlock intervention time

1: Family dependent

Examples:

```
INTIT:0:?
#INTIT:0:10000
```

```
INTIT:1:0
#AK
```

4.10 HPPS Specific Commands

Following commands are HPPS family specific.



4.10.1 DC

The **DC** command is used to evolve the *DC FSM* or to query the *DC State*.

R/W	Command	Response
R	DC:?	#DC:<status>
W	DC:<state>	#AK

Parameters:

status	Mode	Description
ON	R	Capacitor bank reaches the nominal value
	W	<i>DC FSM evolves from DC OFF State to DC Charging State</i>
OFF	R	The capacitor bank is not ready
	W ¹	<i>DC FSM evolves from DC ON State state to DC OFF State</i>

1: In **DC Charging State** it is not possible use **DC:OFF**

The *DC:ON* command cannot be used if DC-link voltage isn't about 0V.

Examples:

```
DC:?  
#DC:OFF
```

```
DC:ON  
#AK
```

4.10.2 MRTIGBT

The **MRTIGBT** command return the maximum IGBTs temperature and the temperature of all 3 IGBTs for every *Power Modules*.

It is possible query the absolute maximum temperature, the temperatures for all modules simultaneously or for a single *Power Module*.

R/W	Command	Response
R	MRTIGBT:?	#MRTIGBT:<max_all>
R	MRTIGBT:ALL:?	#MRTIGBT:ALL:<max_1>:<t_11>:<t_12>:<t_13>:<max_2>:...:<t_xy>:...
R	MRTIGBT:<x>:?	#MRTIGBT:<x>:<max_x>

Parameters:

value	Range	Description
x	[1;2;4] ¹	Number of <i>Power Module</i>
y	[1,3]	Number of IGBT

1: The number of *Power Module* is model dependent (see *PM* command)

max_all / max_x / t_xy	Type	Unit
(Max) IGBTs temperature	float	°C

Examples:

```
MRTIGBT:?  
#MRTIGBT:42.3  
  
MRTIGBT:ALL:?  
#MRTIGBT:ALL:53.4:46.8:47.9:53.4:38.9:36.4:38.9:35.5  
  
MRTIGBT:2:?  
#MRTIGBT:2:53.6
```

4.10.3 PM

The **PM** command return *Power Module Status*.

It is possible query the *Power Module Status* for a single of for every *Power Module*.

This command is used also to get the number of *Power Module* (this parameter is model dependent).

R/W	Command Response	
R	PM:?	#PM:<status_1>:<t_11>:<t_12>:<t_13>:<status_2>:<t_21>:...: <t_xy> :<t_x3>
R	PM:<x>:?	#PM:<x>:<status_x>:<t_x1>:<t_x2>:<t_x3>
R	PM:NUM:?	#PM:NUM:<number>

Parameters:

Name	Type	Range	Unit	Description
x	int	[1;2;4] ¹	-	Power Module ID
y	int	[1,3]	-	IGBT ID
t_xy	float	-	°C	Temperature of <i>Power Module x</i> and IGBT <i>y</i>
status_x	hex	[0x0,0xFF]	-	Power Module Status <i>x</i> (see following table)
number	int	[1;2;4]	-	Number of <i>Power Module</i>

1: The number of *Power Module* is model dependent

status_x	Status mask
IGBT 1 saturation fault	0b00000001 or 0x01
IGBT 2 saturation fault	0b00000010 or 0x02
IGBT 3 saturation fault	0b00000100 or 0x04
IGBT 1 NTC Overtemperature	0b00001000 or 0x08
IGBT 2 NTC Overtemperature	0b00010000 or 0x10
IGBT 3 NTC Overtemperature	0b00100000 or 0x20
Heatsink Overtemperature	0b01000000 or 0x40

<i>status_x</i>	Status mask
Communication Fault	0b10000000 or 0x80

Example:

```
PM:?  
#PM:0x0:46.8:47:9:53:4:0x0:36.4:38.9:35.5
```

```
PM:1:?  
#PM:1:0x2:35.6:38.4:36.9
```

```
PM:NUM:?  
#PM:NUM:2
```

4.10.4 MGC

The **MGC** command returns the leakage ground current.

This command is available only for HPPS-C2-PESY00076 model.

R/W	Command	Response
R	MGC:?	#MGC:<ground_current>

Parameters:

<i>ground_current</i>	Type	Unit
Leakage ground current	float	A

Examples:

```
MGC: ?
#MGC: 0.001
```

4.10.5 MRTW

The **MRTW** command returns the water temperature.

This command is available only for HPPS-C2-PESY00076 model.

R/W	Command	Response
R	MRTW:?	#MRTW:<water_temp>

Parameters:

<i>water_temp</i>	Type	Unit
Water temperature	float	°C

Examples:

```
MRTW: ?
#MRTW: 32.6
```

4.10.6 MRFW

The **MRFW** command returns the water flow.

This command is available only for HPPS-C2-PESY00076 model.

R/W	Command	Response
R	MRFW:?	#MRFW:<water_flow>

Parameters:

water_flow	Type	Unit
Water flow	float	l/min

Examples:

```
MRFW: ?
#MRFW: 1.5
```

4.11 Advanced Features Commands

This section explain some advance power supply functionality.

Power supply allows to generate custom waveform both in *CC Mode* or *CV Mode*.

The *WAVE* command is used to define the waveform, start and stop the generation and select the mode.

The *TRIG* command is used to set the *Trigger Event*.

4.11.1 WAVE

The **WAVE** command allows to perform a custom waveform setpoint input.

To use this functionality it is necessary to set the *WAVE Update Mode* (see *UPMODE* command).

R/W	Command	Response
W	WAVE:START	#AK
W	WAVE:STOP	#AK
R	WAVE:N_PERIODS:?	#WAVE:N_PERIODS:<n_periods>
W	WAVE:N_PERIODS:<n_periods>	#AK
R	WAVE:PRESCALER:?	#WAVE:PRESCALER:<prescaler>
W	WAVE:PRESCALER:<prescaler>	#AK
W	WAVE:POINTS:<p_1>:<p_2>:...:<p_x>	#AK
R	WAVE:POINTS:?	#WAVE:POINTS:<p_1>:<p_2>:...:<p_x>
W	WAVE:TRIGGER:<mode>	#AK
R	WAVE:TRIGGER:?	#WAVE:TRIGGER:<mode>

Name	Type	Default	Range
<i>n_periods</i>	int	0	>=0

The *n_periods* parameter specify the number of periods that has to be executed.

With *n_periods* equal to 0, the waveform will will be executed infinite times (the execution can be stopped anytime with the *WAVE:STOP* command).

Name	Type	Default	Range
<i>prescaler</i>	int	1	[1,100]

The *prescaler* parameter specify the waveform prescaler value. This is used to reduce the default *Update Frequency* and so to increase the length of the waveform.

For example: if the power unit has an *Update Frequency* of 100kHz and the *prescaler* is set to default value 1, the maximum waveform legth will be 5s. With a *prescaler* of 4, the waveform points will be

updated at 25kHz and in this specific case the maximum waveform length will be increase up to 20s). The *Update Frequency* is family/model dependent (see *UPFREQ* command).

Name	Type	Unit	Range
<i>p_x</i>	float	V or A	[5,500'000]

The *p_x* values rapresent the waveform points that have to be executed.

The waveform points will be updated with the module *Update Frequency* (see *UPFREQ* command) divided by the value of the *prescaler*.

The minimum number of points is 5 and the maximum is 500'000.

The points has to be represented in ASCII mode.

mode	Description
START	Starts the waveform execution on <i>Trigger Event</i>
POINTS	Reproduces the next point on <i>Edge Trigger Event</i>
GATE	Waveform execution is enabled using a <i>Level Trigger Event</i>
GATE_RESET	Is the same of <i>GATE</i> , but waveform is rearmed when disabled

mode can be set once the *Trigger Event* is enabled (see *TRIG* command):

- *START*: The waveform execution start on *Trigger Event* (see *TRIG* command). This mode support also a software start using *WAVE:START*. To stop the execution it is necessary use *WAVE:START* command.
- *POINTS*: On *Edge Trigger Event* the next waveform point is reproduced. To arm the waveform execution it is necessary a *WAVE:START* command.
This mode is meant to use the waveform like a buffer of setpoints and at every *Edge Trigger Event* (see *TRIG* command), the next point is executed. For this reason the *prescaler* setting is bypassed.
- *GATE*: The *Level Trigger State* is used as an enable or disable signal. To arm the waveform execution it is necessary to send the *WAVE:START* command.
- *GATE_RESET*: Is the same of *GATE*, but waveform is rearmed when disabled.

In following examples it is used:

- sine waveform of amplitude 1V
- frequency 1Hz

- number of periods 3
- prescaler 1.

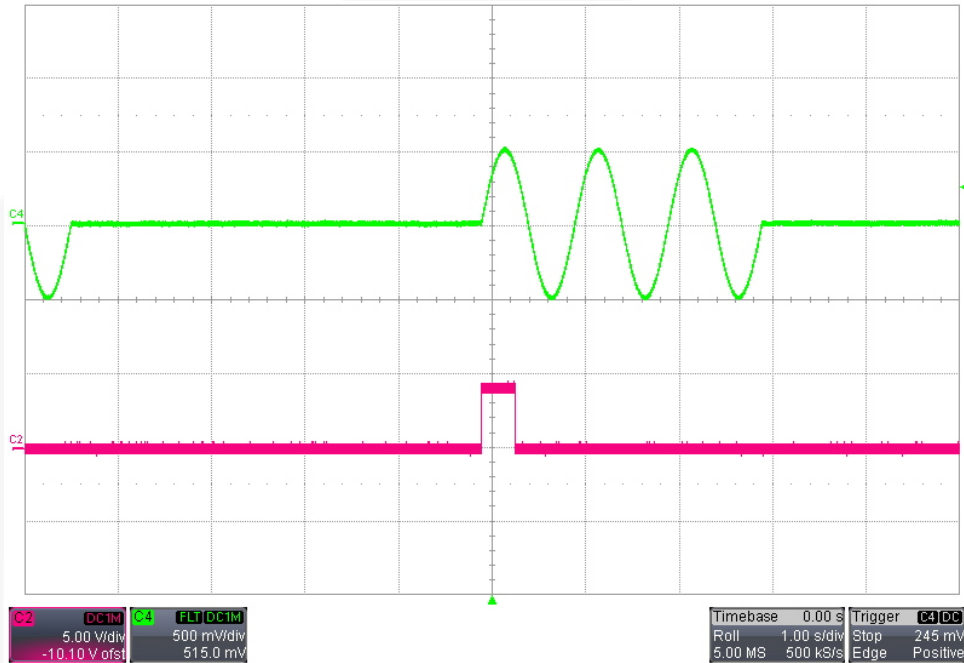

Figure 4.3: WAVEFORM:TRIGGER:START with TRIG:POS option

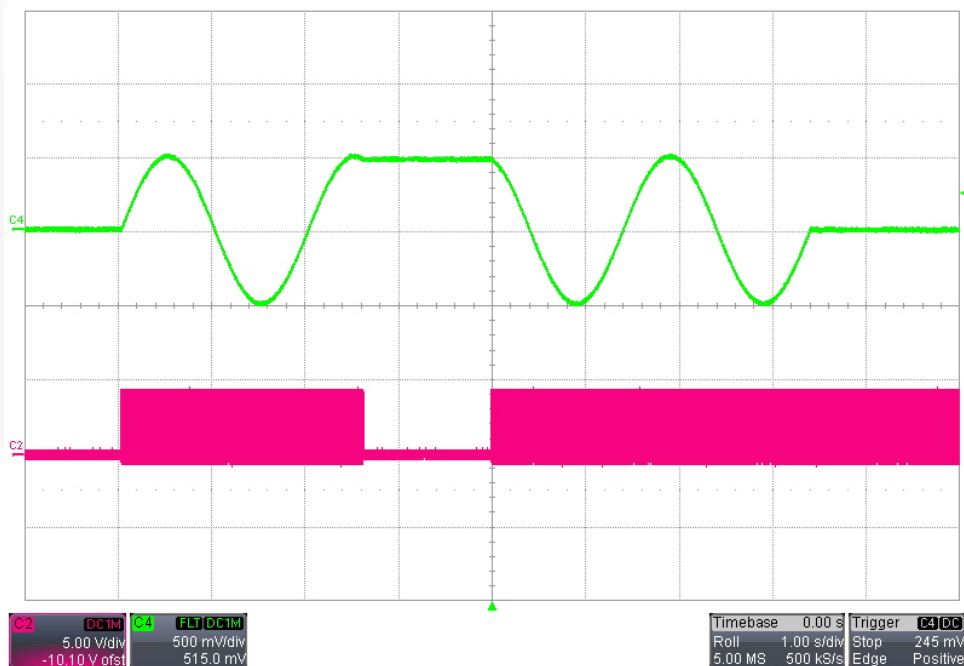

Figure 4.4: WAVEFORM:TRIGGER:POINTS with TRIG:POS option and trigger frequency of 50kHz

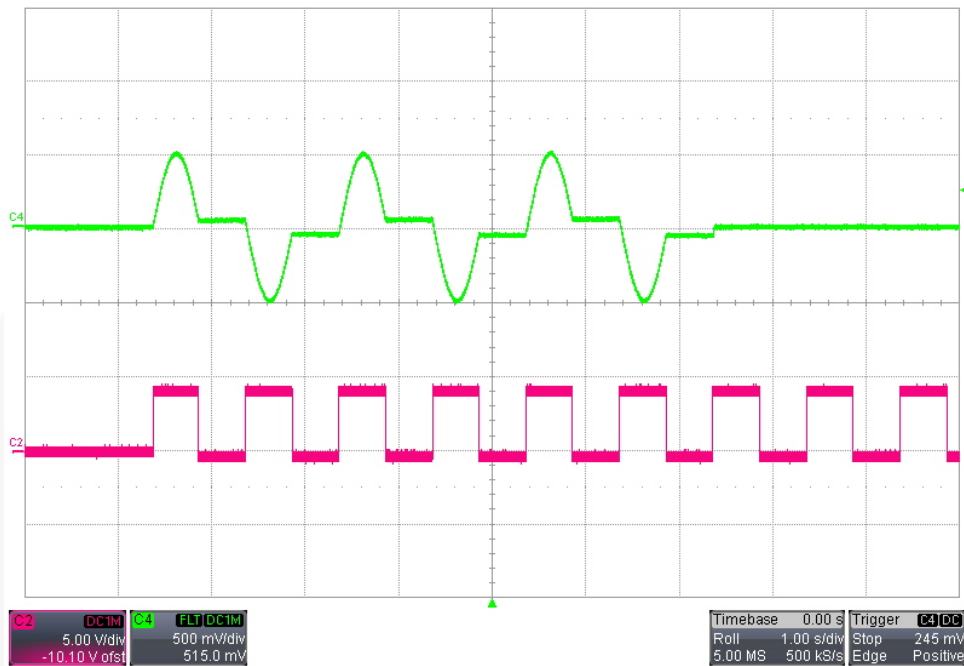

Figure 4.5: WAVEFORM:TRIGGER:GATE with TRIG:HIGH_LEVEL option and trigger frequency of 1 Hz

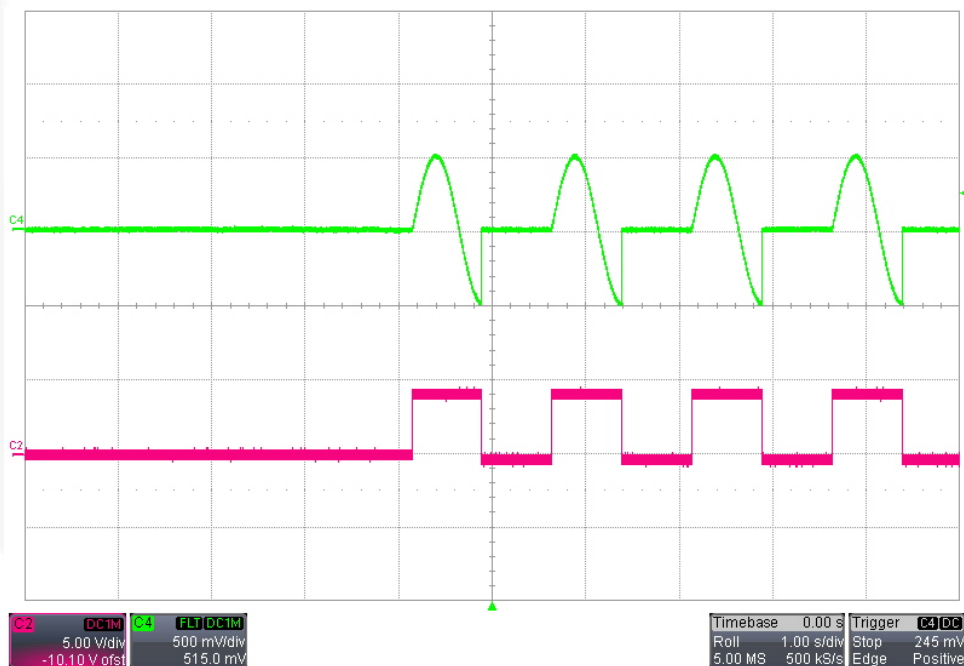

Figure 4.6: WAVEFORM:TRIGGER:GATE_RESET with TRIG:HIGH_LEVEL option and trigger frequency of 0.667 Hz (period 1,5s)

Examples:

```
WAVE:N_PERIODS:?
#WAVE:N_PERIODS:0

WAVE:N_PERIODS:3
#AK

WAVE:PRESCALER:?
#WAVE:PRESCALER:1

WAVE:PRESCALER:10
#AK

WAVE:POINTS:0:10:15:20:10:5:10:...
#AK

WAVE:POINTS:?
#WAVE:POINTS:0:10:15:10:0:5:...

WAVE:TRIGGER:?
#WAVE:TRIGGER:POINTS

WAVE:TRIGGER:START
#AK

WAVE:START
#AK

WAVE:STOP
#AK
```

4.11.2 TRIG

The **TRIG** command is used to enable and set the external trigger.

R/W	Command	Response
R	TRIG:?	#TRIG:<mode>
W	TRIG:<mode>	#AK

mode	Description
OFF	Disable the <i>Trigger Event</i> (default value)
POS	<i>Edge Trigger Event</i> on positive edge
NEG	<i>Edge Trigger Event</i> on negative edge
BOTH	<i>Edge Trigger Event</i> on positive and negative edge
HIGH_LEVEL	<i>Level Trigger Event</i> when signal is high
LOW_LEVEL	<i>Level Trigger Event</i> when signal is low

```
TRIG:?
#TRIG:OFF
```

```
TRIG:POS
#AK
```

4.12 Legacy Commands

This section presents legacy commands.

It is preferable not using them because no longer supported.

4.12.1 MON

The **MON** command is equivalent to *OUT:ON* command (see *OUT* command)

R/W	Command	Response
W	MON	#AK

Examples:

```
MON
#AK
```

4.12.2 MOFF

The **MOFF** command is equivalent to *OUT:OFF* command (see *OUT* command)

R/W	Command	Response
W	MON	#AK

Examples:

```
MOFF
#AK
```

5 Internal Memory

ID	Field	Type	Privileges	Description
0	Firmware ID	string	R-only	Firmware ID
1	Model	string	R-only	Model
2	Serial Number	string	R-only	Serial Number
3	MAC Address	string	R-only	MAC Address
9	Calibration Date	string	R-only	Calibration date
10	Current Calib. Param. a	float	R-only	Current cubic calib. param. a ⁴
11	Current Calib. Param. b	float	R-only	Current cubic calib. param. b ⁴
12	Current Calib. Param. c	float	R-only	Current cubic calib. param. c ⁴
13	Current Calib. Param. d	float	R-only	Current cubic calib. param. d ⁴
14	Voltage Calib. Param. a	float	R-only	Voltage cubic calib. param. a ⁴
15	Voltage Calib. Param. b	float	R-only	Voltage cubic calib. param. b ⁴
16	Voltage Calib. Param. c	float	R-only	Voltage cubic calib. param. c ⁴
17	Voltage Calib. Param. d	float	R-only	Voltage cubic calib. param. d ⁴
18	DC-link Calib. Param. a	float	R-only	DC-link linear calib. param. a ⁵
19	DC-link Calib. Param. b	float	R-only	DC-link linear calib. param. b ⁵
20	DC-link AC Calib. Param. a	float	R-only	DC-link AC linear calib. param. a ⁵
21	DC-link AC Calib. Param. b	float	R-only	DC-link AC linear calib. param. b ⁵
30	Module ID	string	Admin	Default is the serial number [2]
31	Current Slew Rate	float	User	Slew rate used in <i>CC Mode</i> [A/s]
32	Voltage Slew Rate	float	User	Slew rate used in <i>CV Mode</i> [V/s]
35	TFT timeout	int	Admin	LCD timeout [minutes]
40	PID CC Kp_v	float	Admin	Kp Voltage in <i>CC Mode</i>

ID	Field	Type	Privileges	Description
41	PID CC Ki_v	float	Admin	Ki Voltage in <i>CC Mode</i>
42	PID CC Kd_v	float	Admin	Kd Voltage in <i>CC Mode</i>
43	PID CC Kp_i	float	Admin	Kp Current in <i>CC Mode</i>
44	PID CC Ki_i	float	Admin	Ki Current in <i>CC Mode</i>
45	PID CC Kd_i	float	Admin	Kd Current in <i>CC Mode</i>
46	PID CC Max Voltage	float	Admin	Max Voltage in <i>CC Mode</i> [V]
47	PID CC Min Voltage	float	Admin	Min Voltage in <i>CC Mode</i> [V]
48	PID CC Max Current	float	Admin	Max Current in <i>CC Mode</i> [A]
49	PID CC Min Current	float	Admin	Min Current in <i>CC Mode</i> [A]
50	PID CC Mode	float	Admin	CC Mode: 0 single; 1 double
55	Allow Remote OFF	0 1 ¹	Admin	REMOTE OFF in LOCAL Mode
56	Error Code Description	0 1 ¹	Admin	Error description in NAK
57	EPICS on startup	0 1 ¹	Admin	EPICS server on startup
60	PID CV Kp_i	float	Admin	Kp Current in <i>CV Mode</i>
61	PID CV Ki_i	float	Admin	Ki Current in <i>CV Mode</i>
62	PID CV Kd_i	float	Admin	Kd Current in <i>CV Mode</i>
63	PID CV Kp_v	float	Admin	Kp Voltage in <i>CV Mode</i>
64	PID CV Ki_v	float	Admin	Ki Voltage in <i>CV Mode</i>
65	PID CV Kd_v	float	Admin	Kd Voltage in <i>CV Mode</i>
66	PID CV Max Current	float	Admin	Max Current in <i>CV Mode</i> [A]
67	PID CV Min Current	float	Admin	Min Current in <i>CV Mode</i> [A]
68	PID CV Max Voltage	float	Admin	Max Voltage in <i>CV Mode</i> [V]
69	PID CV Min Voltage	float	Admin	Min Voltage in <i>CV Mode</i> [V]
80	Output Over-Current Limit	float ²	Admin	Output current threshold [A]
81	Output Over-Voltage Limit	float ²	Admin	Output voltage threshold [V]
82	Max Temperature	float	Admin	Max Cabinet temperature threshold [°Celsius]
83	Undervoltage Threshold	float	Admin	Undervoltage threshold [V]

ID	Field	Type	Privileges	Description
86	Regulation Fault Current Limit	float	Admin	Current regulation fault [A]
87	Regulation Fault Voltage Limit	float	Admin	Voltage regulation fault [V]
88	Regulation Fault Intervention Time	float	Admin	Regulation time fault [s]
90	Interlock Enable Mask	hex ³	Admin	Interlocks enable
91	Interlock Activation Level Mask	hex ³	Admin	Interlocks polarity
92	Interlock #0 Intervention Time	int	Admin	Interlock 0 intervention time [ms]
93	Interlock #0 Name	string	Admin	Interlock 0 name
94	Interlock #1 Intervention Time	int	Admin	Interlock 1 intervention time [ms]
95	Interlock #1 Name	string	Admin	Interlock 1 name
130	Capabilities	string	R-only	Available capabilities
140	Max IGBT Temperature	float	Admin	IGBT temperature threshold [°Celsius]
141	Charging Timeout	int	R-only	Charging timeout [ms]

1. 0 : disabled; 1 : enabled
2. 0 to disable
3. Format: 0x<mask>
4. Formula: $y=dx^3+cx^2+bx+a$
5. Formula: $y=bx+a$

6 Faults Register

32 LSB are common for all models.

Bit	Name	Description
1	Overtemperature	Max temperature > Max Cabinet temperature threshold see <i>Temperatures</i> chapter see <i>Internal Memory</i> chapter ID 82
2	DC Link Undervoltage	DC-Link voltage < Undervoltage threshold see <i>Internal Memory</i> chapter ID 83
4	Overpower	Power out of <i>Power Limits</i>
7	Regulation Fault	Output not reaches the setpoint range in time see <i>Internal Memory</i> chapter ID 86,87 and 88
9	DCCT Error	DCCT is not connected
14	Output Overcurrent	Output current > Output Over-Current Limit see <i>Internal Memory</i> chapter ID 80
15	Output Overvoltage	Output voltage > Output Over-Voltage Limit see <i>Internal Memory</i> chapter ID 81
17	Interlock #0	Interlock 0 event
18	Interlock #1	Interlock 1 event
19	Interlock #2	Interlock 2 event
20	Interlock #3	Interlock 3 event

32 MSB are model dependent.

Use *MRG:1:?* command to get the model (see *MRG* command)

HPPS-HP04000300EX

Bit	Name	Description
33	Overtemp. Module 1	Overtemperature of the <i>Power Module 1</i>
37	Driver Fault	Driver fault from <i>Power Module</i>
38	Module Communication Fault	Communication fault with <i>Power Module</i>
39	Charging Timeout	Main contactor timeout
41	Emergency Button	Emergency button pressed
42	3 Phase Fault	Three-phase loss
43	Door State Fault	Door opened
44	Water Flow Fault	Water flow loss
45	Transformer Overtemp.	Trasformer overtemperature
46	Rectifier Overtemp.	Diode rectifier heatsink overtemperature
47	Main Contactor Fault	Wrong main contactor status
48	Inductors Overtemp.	DC or output inductors overtemperature
49	IGBT Heatsink Overtemp.	Power Module heatsink overtemperature
50	Damp Resistor Overtemp.	Output filter resistor overtemperature
51	Cabinet Overtemp. Switch	Cabinet overtemperature
52	Res. Precharge Overtemp.	Precharge resistors overtemperature

HPPS-HP800520MOEH

Bit	Name	Description
33	Overtemp. Module 1	Overtemperature of the <i>Power Module 1</i>
37	Driver Fault	Driver fault from <i>Power Module</i>
38	Module Communication Fault	Communication fault with <i>Power Module</i>
39	Charging Timeout	Main contactor timeout
41	Emergency Button	Emergency button pressed
42	3 Phase Fault	Three-phase loss
43	Door State Fault	Door opened
44	Water Flow Fault	Water flow loss
45	Transformer Overtemp.	Trasformer overtemperature
46	Rectifier Overtemp.	Diode rectifier heatsink overtemperature
47	Main Contactor Fault	Wrong main contactor status
48	DC Inductors Overtemp.	DC inductor overtemperature
49	IGBT Heatsink Overtemp.	Power Module heatsink overtemperature
50	Damp/Precharge Res. Overtemp.	Output filter resistor or precharge resistor overtemperature
51	Cabinet Overtemp. Switch	Cabinet overtemperature
52	Out Inductors OverTemp.	Output inductors Overtemperature

HPPS-HP120108BIEH

Bit	Name	Description
33	Overtemp. Module 1	Overtemperature of the <i>Power Module 1</i>
37	Driver Fault	Driver fault from <i>Power Module</i>
38	Module Communication Fault	Communication fault with <i>Power Module</i>
39	Charging Timeout	Main contactor timeout
41	Emergency Button	Emergency button pressed
42	3 Phase Fault	Three-phase loss
43	Door State Fault	Door opened
44	Water Flow Fault	Water flow loss
45	Transformer Overtemp.	Trasformer overtemperature
46	Rectifier Overtemp.	Diode rectifier heatsink overtemperature
47	Main Contactor Fault	Wrong main contactor status
48	DC Inductors Overtemp.	DC inductor overtemperature
49	IGBT Heatsink Overtemp.	Power Module heatsink overtemperature
50	Damp Resistor Overtemp.	Output filter resistor overtemperature
51	Cabinet Overtemp. Switch	Cabinet overtemperature
52	Out Inductors OverTemp.	Output inductors Overtemperature

HPPS-HP1K0240BIEH

Bit	Name	Description
33	Overtemp. Module 1	Overtemperature of the <i>Power Module 1</i>
34	Overtemp. Module 2	Overtemperature of the <i>Power Module 2</i>
37	Driver Fault	Driver fault from <i>Power Module</i>
38	Module Communication Fault	Communication fault with <i>Power Module</i>
39	Charging Timeout	Main contactor timeout
41	Emergency Button	Emergency button pressed
42	3 Phase Fault	Three-phase loss
43	Door State Fault	Door opened
44	Water Flow Fault	Water flow loss
45	Transformer Overtemp.	Trasformer overtemperature
46	Rectifier Overtemp.	Diode rectifier heatsink overtemperature
47	Main Contactor Fault	Wrong main contactor status
48	DC Inductors Overtemp.	DC inductor overtemperature
49	IGBT Heatsink Overtemp.	Power Module heatsink overtemperature
50	Damp/Precharge Res. Overtemp.	Output filter resistor or precharge resistor overtemperature
51	Cabinet Overtemp. Switch	Cabinet overtemperature
52	Out Inductors OverTemp.	Output inductors Overtemperature

HPPS-PESY00053

Bit	Name	Description
33	Overtemp. Module 1	Overtemperature of the <i>Power Module 1</i>
37	Driver Fault	Driver fault from <i>Power Module</i>
38	Module Communication Fault	Communication fault with <i>Power Module</i>
39	Charging Timeout	Main contactor timeout
41	Emergency Button	Emergency button pressed
42	3 Phase Fault	Three-phase loss
43	Door State Fault	Door opened
44	Water Flow Fault	Water flow loss
45	Magn. and Cab. Overtemp.	Magnetics or cabinet overtemperature
46	Rectifier or PM Overtemp.	Diode rectifier heatsink or <i>Power Module</i> overtemperature
47	Main Contactor Fault	Wrong main contactor status
50	Damp Resistor Overtemp.	Output filter resistor overtemperature
52	Ground Fault	Ground breaker tripped

HPPS-HP650110MOEH

Bit	Name	Description
33	Overtemp. Module 1	Overtemperature of the <i>Power Module 1</i>
37	Driver Fault	Driver fault from <i>Power Module</i>
38	Module Communication Fault	Communication fault with <i>Power Module</i>
39	Charging Timeout	Main contactor timeout
41	Emergency Button	Emergency button pressed
42	3 Phase Fault	Three-phase loss
43	Door State Fault	Door opened
44	Water Flow Fault	Water flow loss
45	Transformer Overtemp.	Trasformer overtemperature
46	Rectifier Overtemp.	Diode rectifier heatsink overtemperature
47	Main Contactor Fault	Wrong main contactor status
48	DC Inductors Overtemp.	DC inductor overtemperature
49	IGBT Heatsink Overtemp.	Power Module heatsink overtemperature
50	Damp Resistor Overtemp.	Output filter resistor overtemperature
51	Precharge Res. Overtemp.	Precharge resistor overtemperature
52	Out Inductors OverTemp.	Output inductors Overtemperature

HPPS-PESY00068

Bit	Name	Description
33	Overtemp. Module 1	Overtemperature of the <i>Power Module 1</i>
37	Driver Fault	Driver fault from <i>Power Module</i>
38	Module Communication Fault	Communication fault with <i>Power Module</i>
39	Charging Timeout	Main contactor timeout
41	Emergency Button	Emergency button pressed
42	3 Phase Fault	Three-phase loss
43	Door State Fault	Door opened
44	Water Flow Fault	Water flow loss
45	Transformer Overtemp.	Trasformer overtemperature
46	Rectifier or PM Overtemp.	Diode rectifier heatsink or <i>Power Module</i> overtemperature
47	Main Contactor Fault	Wrong main contactor status
48	DC Inductors Overtemp.	DC inductor overtemperature
49	Ground Fault detected	Ground breaker tripped
50	Damp Resistor Overtemp.	Output filter resistor overtemperature
51	Precharge Res. Overtemp.	Precharge resistor overtemperature
52	Out Inductors OverTemp.	Output inductors Overtemperature

HPPS-PESY00073

Bit	Name	Description
33	Overtemp. Module 1	Overtemperature of the <i>Power Module 1</i>
37	Driver Fault	Driver fault from <i>Power Module</i>
38	Module Communication Fault	Communication fault with <i>Power Module</i>
39	Charging Timeout	Main contactor timeout
41	Emergency Button	Emergency button pressed
42	3 Phase Fault	Three-phase loss
43	Door State Fault	Door opened
44	Water Flow Fault	Water flow loss
45	Transformer Overtemp.	Trasformer overtemperature
46	Rectifier Overtemp.	Diode rectifier heatsink overtemperature
47	Main Contactor Fault	Wrong main contactor status
48	DC Inductors Overtemp.	DC inductor overtemperature
49	IGBT Heatsink Overtemp.	Power Module heatsink overtemperature
50	Damp Resistor Overtemp.	Output filter resistor overtemperature
51	Precharge Res. Overtemp.	Precharge resistor overtemperature
52	Out Inductors OverTemp.	Output inductors Overtemperature

HPPS-C2-PESY00076

Bit	Name	Description
33	Overtemp. Module 1	Overtemperature of the <i>Power Module 1</i>
37	Driver Fault	Driver fault from <i>Power Module</i>
38	Module Communication Fault	Communication fault with <i>Power Module</i>
39	Charging Timeout	Main contactor timeout
41	Emergency Button	Emergency button pressed
42	3 Phase Fault	Three-phase loss
43	Door State Fault	Door opened
44	Water Flow Fault	Water flow loss
45	Transformer Overtemp.	Trasformer overtemperature
46	Rectifier Overtemp.	Diode rectifier heatsink overtemperature
47	Main Contactor Fault	Wrong main contactor status
48	DC Inductors Overtemp.	DC inductor overtemperature
49	IGBT Heatsink Overtemp.	<i>Power Module</i> heatsink overtemperature
50	Damp Resistor Overtemp.	Output filter resistor overtemperature
51	Water Overtemp. Switch	Water overtemperature switch
52	Out Inductors Overtemp.	Output inductors overtemperature
53	3 Phase Curr. Unbalance	3 phase current unbalance
54	Ground Fault	Ground fault

7 Status Register

Bit	Value	Description
1	0	Module is not in <i>OUT ON State</i>
	1	Module is in <i>OUT ON State</i>
2	0	Module is not in <i>Fault State</i>
	1	Module is in <i>Fault State</i>
3	0	Module is not in <i>OUT Wait for Off State</i>
	1	Module is in <i>OUT Wait for Off State</i>
5	0	<i>Loop Mode</i> is <i>CC Mode</i>
	1	<i>Loop Mode</i> is <i>CV Mode</i>
9-10	00	<i>Update Mode</i> is <i>NORMAL</i>
	10	<i>Update Mode</i> is <i>WAVE</i>
13	0	<i>Trigger Event</i> is disabled
	1	<i>Trigger Event</i> is enabled
17	0	Ramp is disabled
	1	Ramp is enabled
18	0	A custom wave is not in execution
	1	A custom wave is in execution
23	0	<i>Local Mode</i> is enabled
	1	<i>Local Mode</i> is disabled

Bit	Value	Description
33	0	Module is not in <i>DC ON State</i>
	1	Module is in <i>DC ON State</i>
34	0	Module is not in <i>DC Charging State</i>
	1	Module is in in <i>DC Charging State</i>

8 Temperatures

ID	Name
1	Temperature Cabinet 1
2	Temperature Cabinet 2
3	Shunt Temperature
Max	Max(Temp_1, Temp_2)

9 NAK List

Code	Description
01	Unknown Command
02	Unknown Parameter
03	Invalid Parameter
04	Not Enough Arguments
05	Privilege Level Requirement not met
06	Save Error on device
07	Invalid Password
08	Module is in Fault state
09	Module is in ON state
10	Parameter is out of hardware limits
11	Parameter is out of defined limits
12	Parameter is not a number
13	Module is in OFF state
14	Slew rate out of limits
15	Device is set in local mode, cannot modify values from remote interface while in this state
16	Module is not currently generating a waveform
17	Module is currently generating a waveform
18	Device is in remote mode, cannot modify values from local interface while in this state
19	Loop mode already set to desired value
20	Loop mode is not the same that uses the variable required to change
21	Module is not in normal update mode

Code	Description
22	Float mode already set to desired value
23	Unknown sub-command for SFP command
24	Unknown feature or feature not available
25	Parallel fault
26	Waveform error
27	Cannot open the required file
28	Cannot change set point because the module is inverting polarity
29	Cannot write waveform data
30	Polarity switch not allowed
31	Cannot set options for socket used by oscilloscope
32	Cannot change settings because in parallel slave mode
33	MASTER and SLAVES have different firmware versions
34	MASTER and SLAVES are different models
35	MASTER and SLAVES have different ratings
36	The required feature is not available
37	UDP buffer overflow
38	Module is in WAIT FOR OFF state
39	The debug field is read only
40	Cannot parse input name for debug field
41	Cannot parse input value for debug field
42	Cannot parse type for debug field
43	DHCP is enabled
44	The specified command is disabled
45	Output current fault
46	Dissipative Unit Enabled
47	DC-link not ready
48	EPICS is disabled

Code	Description
49	Module is not in wave update mode
50	DC-link is not in OFF condition
51	SFP is not available
52	NTP is active
80	Post Mortem Monitor is not ready
99	Unknown Error
